

V = 40 m³, A: 10.180 mm, E: 3.440 mm, B: 8.600 mm, F: 1.900 mm

Wywrotka aluminiowa tylnozsypowa - kłapa wewnętrzna

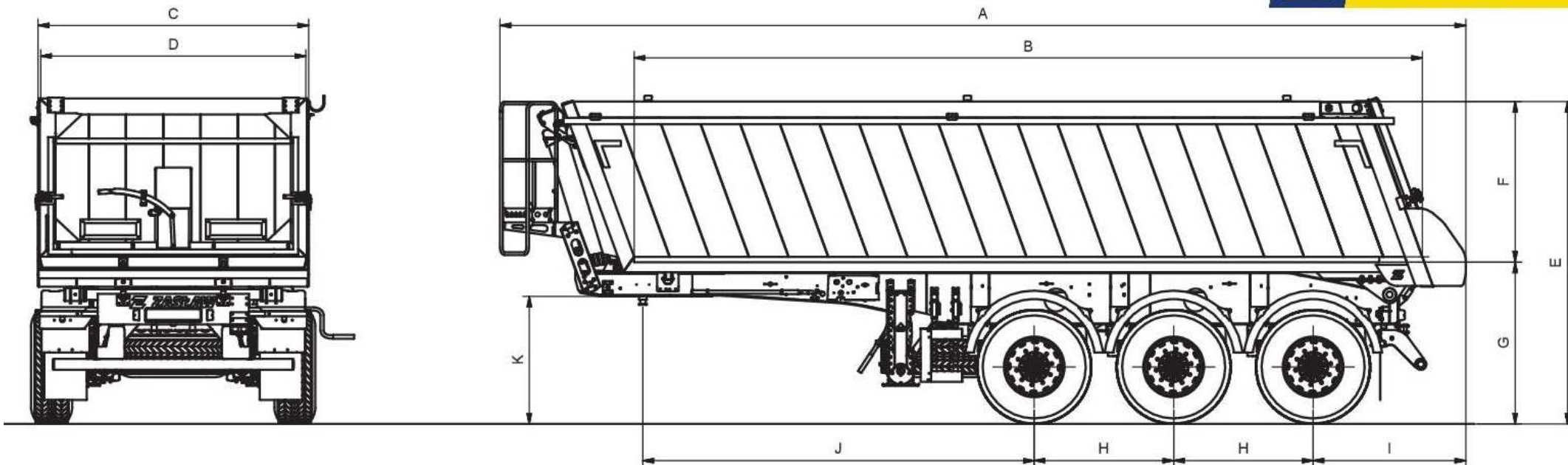

www.zaslaw-trails.pl / mail: info@zaslaw-trails.pl